

## Three Phase Rectifier Bridge Module

$V_{RRM}$  1200 to 1800V  
 $I_D$  35 Amp



### Features

- Aluminum oxide DBC
- Glass passivated chip

### Applications

- Inverter for AC or DC motor control
- Current stabilized power supply
- Switching power supply

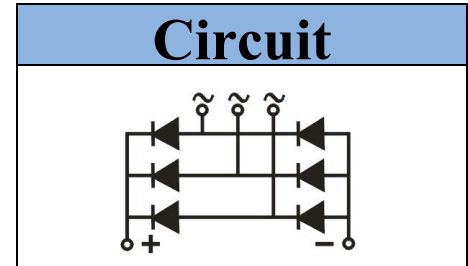

### Module Type

Type	$V_{RRM}$	$V_{RSM}$
PDSB3512	1200V	1300V
PDSB3514	1400V	1500V
PDSB3516	1600V	1700V
PDSB3518	1800V	1900V

### Maximum Ratings

Symbol	Item	Conditions	Values	Unit
$I_D$	Output Current	Three Phase, Full Wave $T_c = 111^\circ\text{C}$	35	A
$I_{FSM}$	Surge Forward Current	$T_j = 25^\circ\text{C}$ , $t = 50\text{Hz}(10\text{ms})$ , $V_R = 0\text{V}$	400	A
$I^2t$	Circuit Fusing Consideration	$t = 10\text{ms}$ $T_j = 25^\circ\text{C}$	800	$\text{A}^2\text{s}$
$V_{ISO}$	Isolation Breakdown Voltage	AC 50Hz/60Hz; R.M.S; 1min	3000	V
$T_j$	Operating Junction Temperature		-40 to +150	$^\circ\text{C}$
$T_{stg}$	Storage Temperature		-40 to +125	$^\circ\text{C}$
$M_s$	Mounting Torque	To Heatsink(M4)	$2 \pm 15\%$	$\text{N} \cdot \text{m}$
Weight	Module (Approximately)		17	g

### Thermal Characteristics

Symbol	Item	Conditions	Values	Unit
$R_{th(j-c)}$	Thermal Impedance, Max	Junction to Case(Per Module)	0.38	$^\circ\text{C}/\text{W}$
		Junction to Case(Per Diode)	2.28	$^\circ\text{C}/\text{W}$

### Electrical Characteristics

Symbol	Item	Conditions	Values			Unit
			Min.	Typ.	Max.	
$V_{FM}$	Forward Voltage Drop, Max	$T_j = 25^\circ\text{C}$ $I_F = 35\text{A}$	—	—	1.50	V
$I_{RRM}$	Repetitive Peak Reverse Current, Max	$T_j = 25^\circ\text{C}$ $V_R = V_{RRM}$	—	—	0.1	mA
		$T_j = 150^\circ\text{C}$ $V_R = V_{RRM}$	—	—	5	
$V_{T0}$	Threshold Voltage, for power loss calculation only	$T_j = 125^\circ\text{C}$	0.95			V
$r_T$	Slope Resistance, for power loss calculation only	$T_j = 125^\circ\text{C}$	14.3			$\text{m}\Omega$

**Performance Curves**

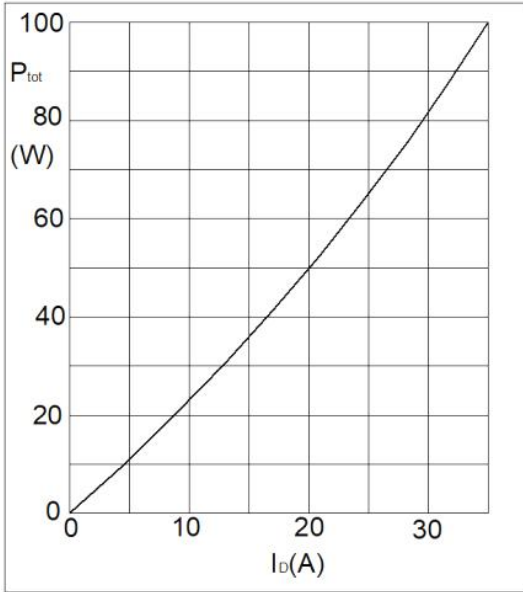

**Fig1. Power Dissipation**

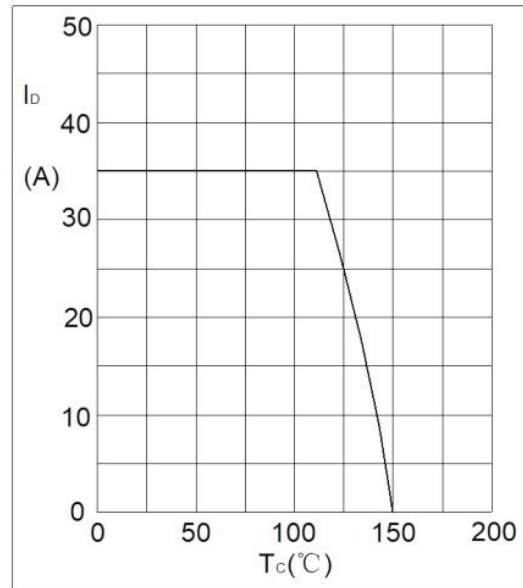

**Fig2. Forward Current Derating Curve**

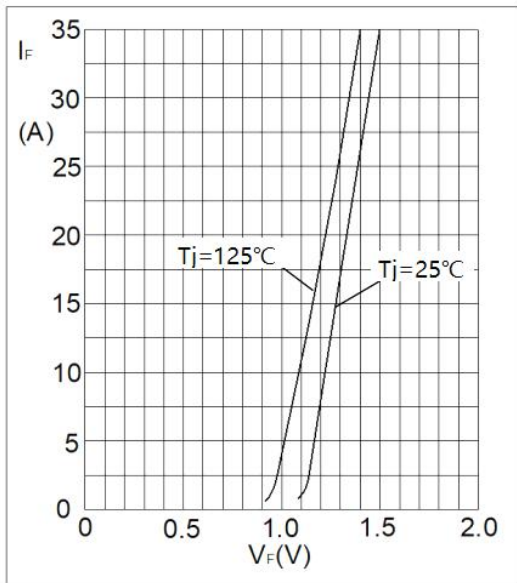

**Fig3. Forward Characteristics**

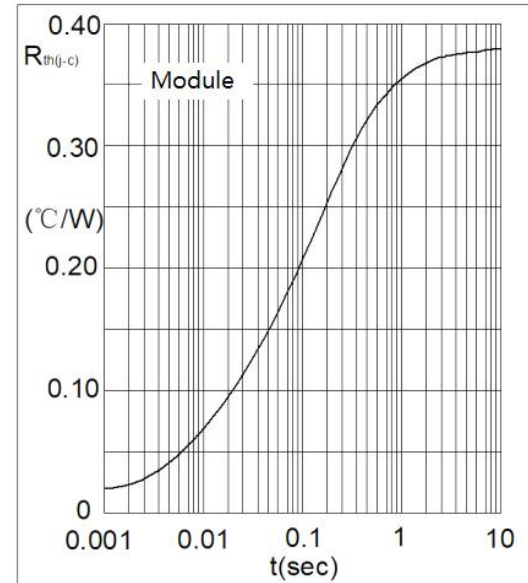

**Fig4. Transient Thermal impedance**

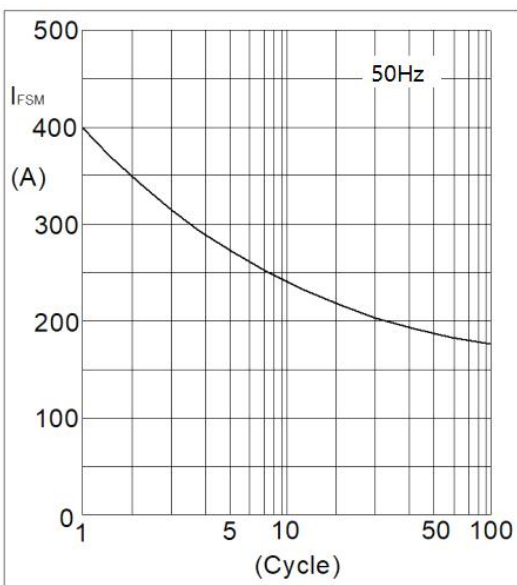

**Fig5. Max Non-Repetitive Forward Surge Current**

Package Outline Information

**CASE: M32**

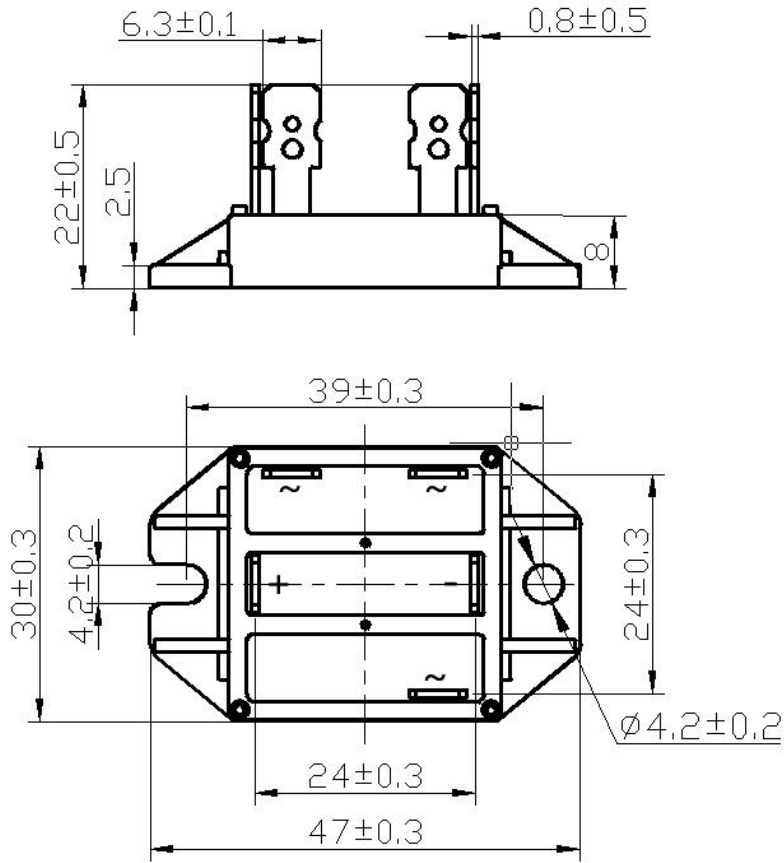

**Dimensions in mm**

**\*IMPORTANT INFORMATION AND WARNINGS**

The specifications of Zhejiang Guchi Electronics Co., Ltd. products may not be considered as a guarantee or assurance of product characteristics. The specifications describe only the usual characteristics of products expected in typical applications, which may still vary depending on the specific application. Therefore, products must be tested for the respective application in advance, and application adjustments may be necessary. The user of our products is responsible for the safety of their applications embedding our products and must take adequate safety measures to prevent the applications from causing physical injury, fire, or other problems if any of our products become faulty. The user is responsible for ensuring that the application design complies with all applicable laws, regulations, norms, and standards. Except as otherwise explicitly approved by Zhejiang Guchi Electronics Co., Ltd. in a written document signed by authorized representatives, our products may not be used in any applications where a failure of the product or any consequences of the use thereof can reasonably be expected to result in personal injury.

No representation or warranty is given, and no liability is assumed with respect to the accuracy, completeness, and/or use of any information herein, including without limitation, warranties of non-infringement of intellectual property rights of any third party. Zhejiang Guchi Electronics Co., Ltd. does not assume any liability arising out of the applications or use of any product; neither does it convey any license under its patent rights, copyrights, trade secrets, or other intellectual property rights, nor the rights of others. We make no representation or warranty of non-infringement or alleged non-infringement of intellectual property rights of any third party which may arise from applications. Due to technical requirements, our products may contain dangerous substances. For information on the types in question, please contact the nearest sales office. This document supersedes and replaces all information previously supplied and may be superseded by updates. We reserve the right to make changes.